

TECHNICKÝ LIST



ČD-46 NEREZ

310x160

NEREZ

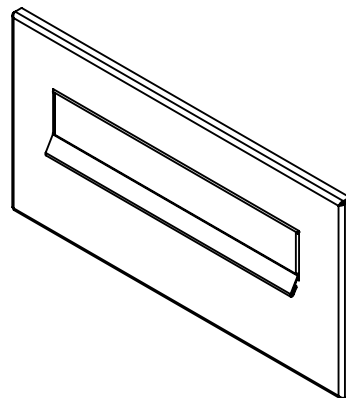
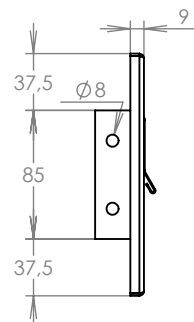
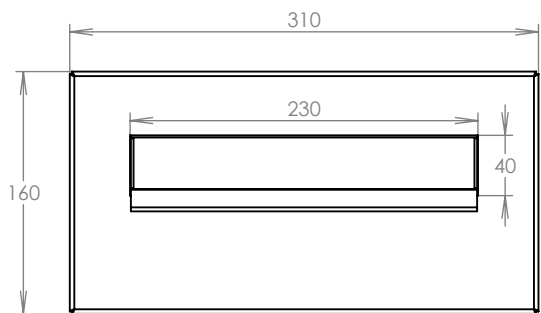

Technická data:

rozměr	310x160 mm
materiál sklapka	plech z nerezové oceli tl. 0,8 mm, délka = 229 mm
materiál čelní deska	plech z nerezové oceli tl. 1,5 mm
určeno	exteriér

WWW.KOVOSYSTEM.CZ

Platnost od 9.5.2021

TECHNICKÝ LIST



ČD-16 NEREZ

310x160

NEREZ

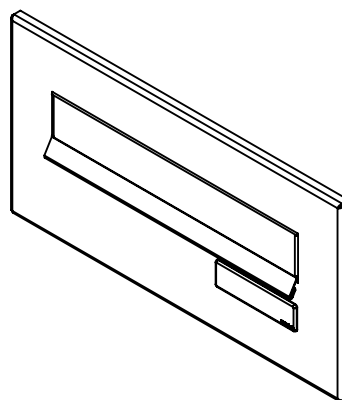
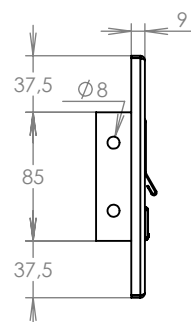
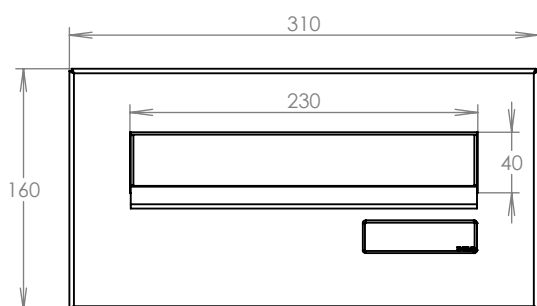

Technická data:

rozměr	310x160 mm
materiál sklapka	plech z nerezové oceli tl. 0,8 mm, délka = 229 mm
materiál čelní deska	plech z nerezové oceli tl. 1,5 mm
jmenovka	jmenovka 75,5x21,6 mm SCANTEC PC S75R
určeno	exteriér

WWW.KOVOSYSTEM.CZ

Platnost od 9.5.2021

TECHNICKÝ LIST



ČD-26 NEREZ

310x160

NEREZ

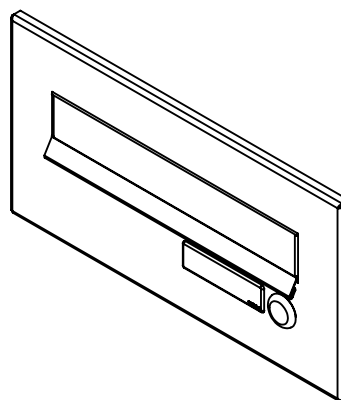
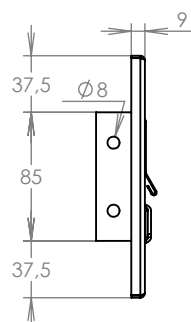
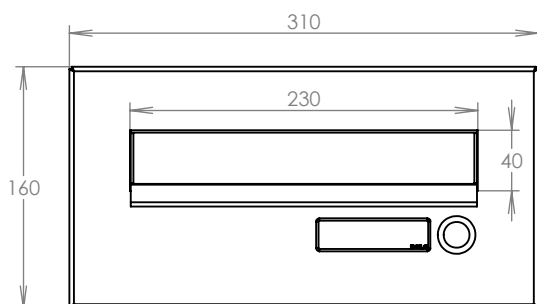

Technická data:

rozměr	310x160 mm
materiál sklapka	plech z nerezové oceli tl. 0,8 mm, délka = 229 mm
materiál čelní deska	plech z nerezové oceli tl. 1,5 mm
zvonkové tlačítko	VS 19-B-1-S Nerez D=19mm, ANTIVANDAL
jmenovka	jmenovka 75,5x21,6 mm SCANTEC PC S75R
určeno	exteriér

WWW.KOVOSYSTEM.CZ

Platnost od 9.5.2021

TECHNICKÝ LIST



ČD-36 NEREZ

310x160

NEREZ

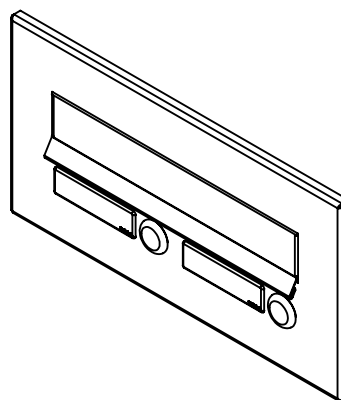
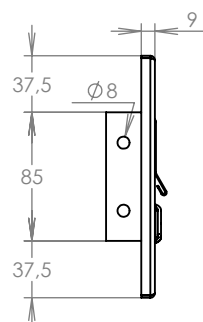
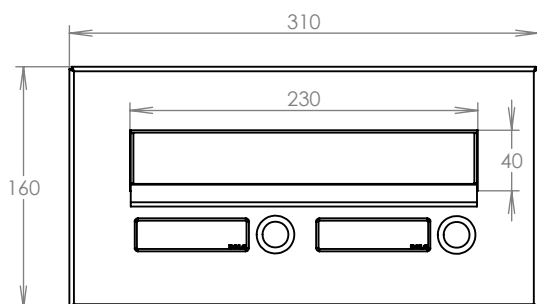

Technická data:

rozměr	310x160 mm
materiál sklapka	plech z nerezové oceli tl. 0,8 mm, délka = 229 mm
materiál čelní deska	plech z nerezové oceli tl. 1,5 mm
zvonkové tlačítko	VS 19-B-1-S Nerez D=19mm, ANTIVANDAL
jmenovka	jmenovka 75,5x21,6 mm SCANTEC PC S75R
určeno	exteriér

WWW.KOVOSYSTEM.CZ

Platnost od 9.5.2021